

# Polytunnel

## Instruction Manual



### After Sales Support

Call 0871 911 7031

Email  
[customerservice@gardengearonline.co.uk](mailto:customerservice@gardengearonline.co.uk)

Product Code: G3350

Thank you for purchasing this product, which has been made to demanding high quality standards and is guaranteed for domestic use against manufacturing faults for a period of 12 months from date of purchase

For correct usage, please read these instructions carefully before first use and store in a safe place for future reference.





## INTRODUCTION

### Congratulations

You have made an excellent choice with the purchase of this quality Garden Gear product.

By doing so you now have the assurance and peace of mind which comes from purchasing a product that has been manufactured to the highest standards, performance and safety.

We want you to be completely satisfied with your purchase, so this Garden Gear product is backed by our full 12 month manufacturers guarantee and an outstanding after sales service through our dedicated Helpline.

Register your product for an extended 2-year warranty by visiting our website [www.gardengearonline.co.uk](http://www.gardengearonline.co.uk). The product must be registered, along with your contact information, within 30 days of purchase. For full terms and conditions please visit our website.

We hope you enjoy using your purchase for many years to come.















## General information and safety warnings

- Carefully unpack the product and ensure that you have all the correct parts.
- Assemble on a dry, calm day
- Locate your polytunnel in a sheltered yet sunny spot
- Assemble the polytunnel on a flat, level surface.
- Lay out everything that you need on a flat, soft and level surface.
- We recommend that two people assemble this polytunnel
- Open your polytunnel during the day to allow plenty of fresh air to circulate around the plants
- Always close and secure the door flap when not in use.
- We recommend that you choose a location for the shed that is not overly exposed to wind.
- We advise that all windows and the door are securely closed when high winds are forecasted.

## Assembly

- Follow diagram for assembly, ensuring that the tubes are fully seated in the connectors before continuing.
- The polytunnel is supplied with rope and pegs for stability, please secure these after completing the assembly.

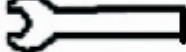
## Parts list

no.		pcs
1		12
2		7
3		7
4		3
5		3
6		2
7		2
8		4
9		4
A	 M6x55mm	21
B	 M6x30mm	6
C		4
E		14
F		2
G		4
PE		1

## Assembly

Start by assembling the base using parts 6 and 7, secure with screws (part B).

Connect the support tubes, parts 8 and 9, with screws (part B).

Fit the base corners by using parts 2, 4, 6, 8 and 2, 5, 7, 8 and secure with screws (part A).

Assemble the arches by using parts 1, 4 and 5, secure with screws (part A).

Secure the arch tubes, parts 1 and cross bar, part 2 with screws (part A).

Step 1-1

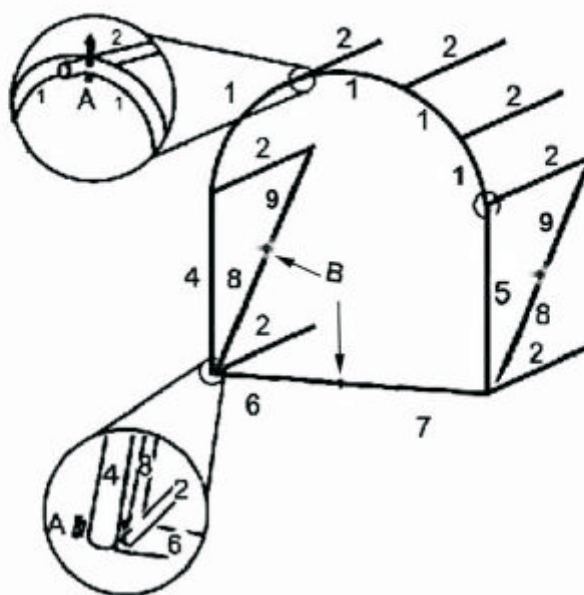

Step 1-2

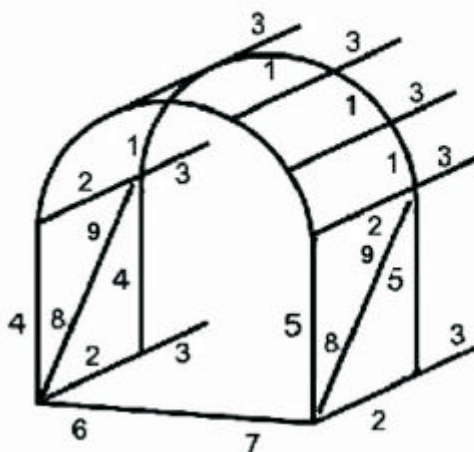

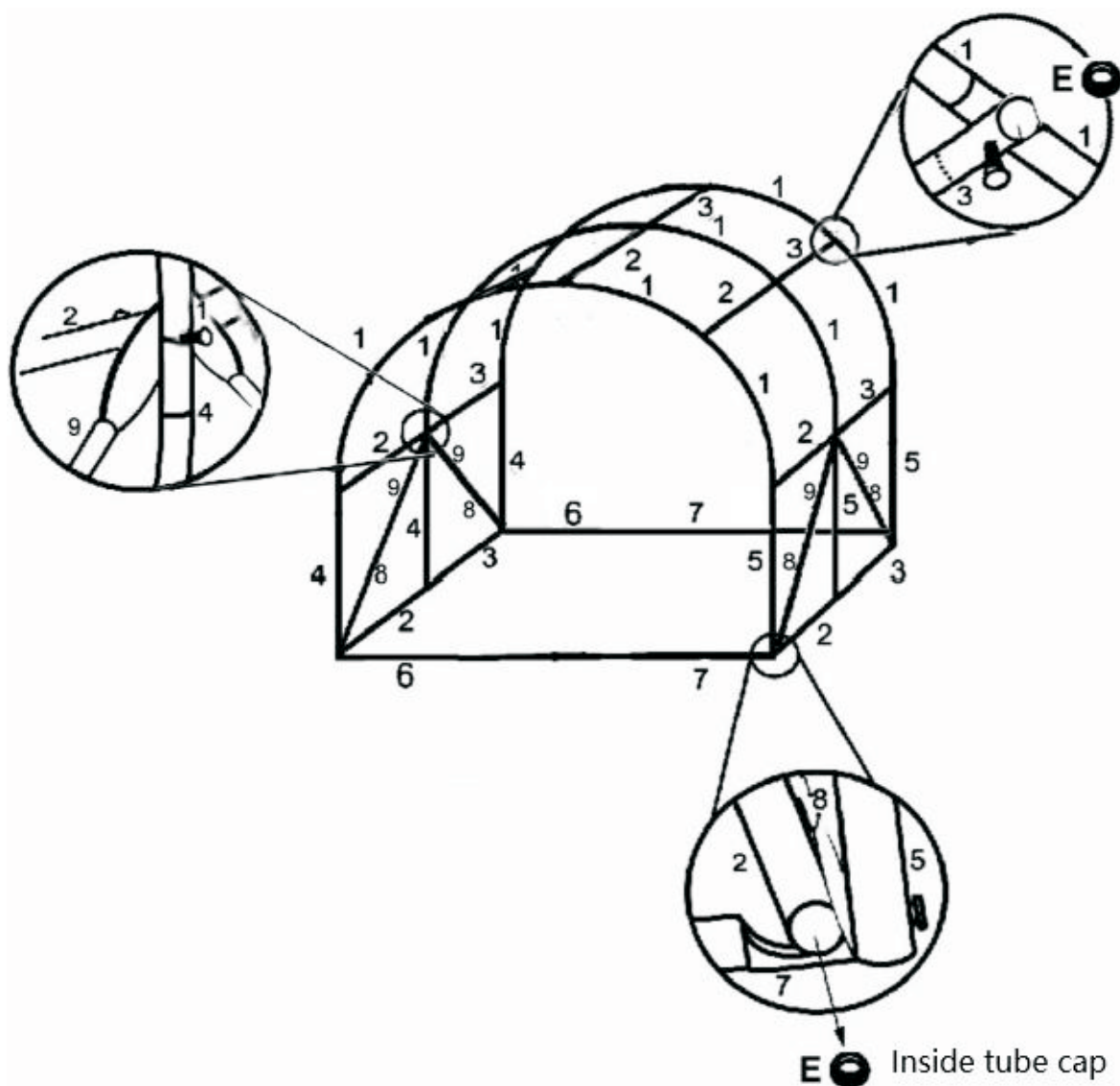

If you would like to purchase a replacement cover, please call our dedicated customer service team and quote the number G3351. Alternatively, please visit our website [www.gardengearonline.co.uk](http://www.gardengearonline.co.uk)

## GUARANTEE

### IMPORTANT

**Please do not return this product without first calling the Customer Service number below:  
0871 911 7031**

Thank you for purchasing this product, which has been made to demanding high quality standards and is guaranteed for domestic use against manufacturing faults for a period of 12 months from the date of purchase.

Register your product for an extended 2-year warranty by visiting our website [www.gardengearonline.co.uk](http://www.gardengearonline.co.uk). The product must be registered, along with your contact information, within 30 days of purchase. For full terms and conditions please visit our website.

This guarantee does not affect your statutory rights. If your product fails due to a defect in material or workmanship during this period, please return it to the place of purchase. Normal wear and tear is not covered under the guarantee.

Any guarantee is invalid if the product has been misused or subject to neglect or an attempted repair other than by our own service centre.

Due to continuous product improvement, we reserve the right to change the product specification without prior notice.

#### **After Sales Customer Service:**

Customer Service Department, Branded Garden Products Ltd, Premier House, Hortonwood 7, Telford, TF1 7GP

Telephone: 0871 911 7031

E-mail [customerservice@gardengearonline.co.uk](mailto:customerservice@gardengearonline.co.uk)

Please retain for future reference.  
Colours and contents may vary.

Calls cost 13p per minute, plus your phone company's access charge.